

1.

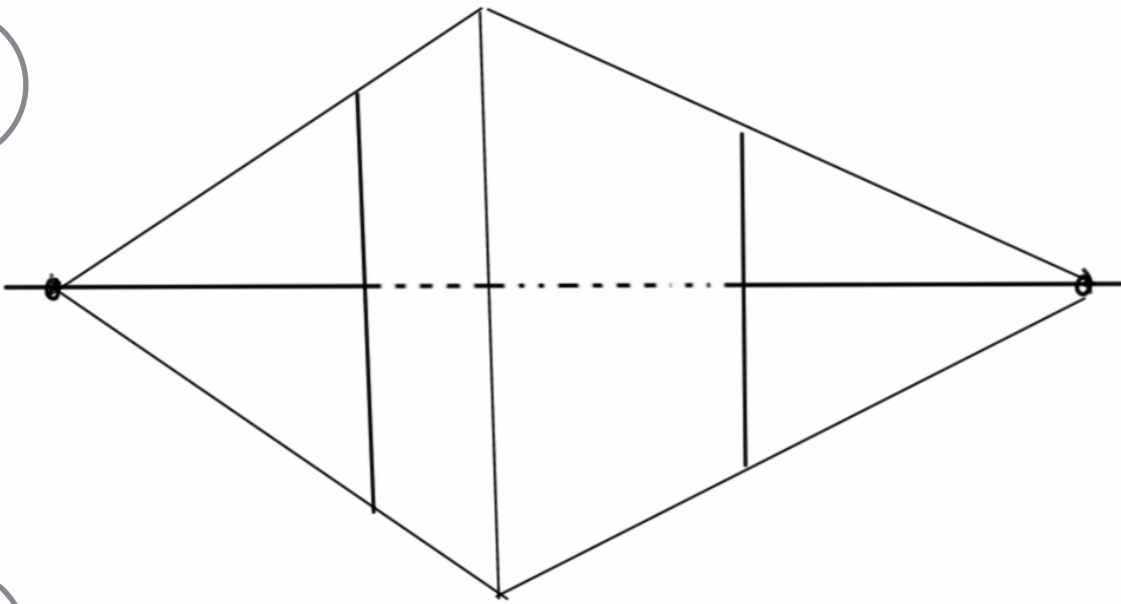

2.

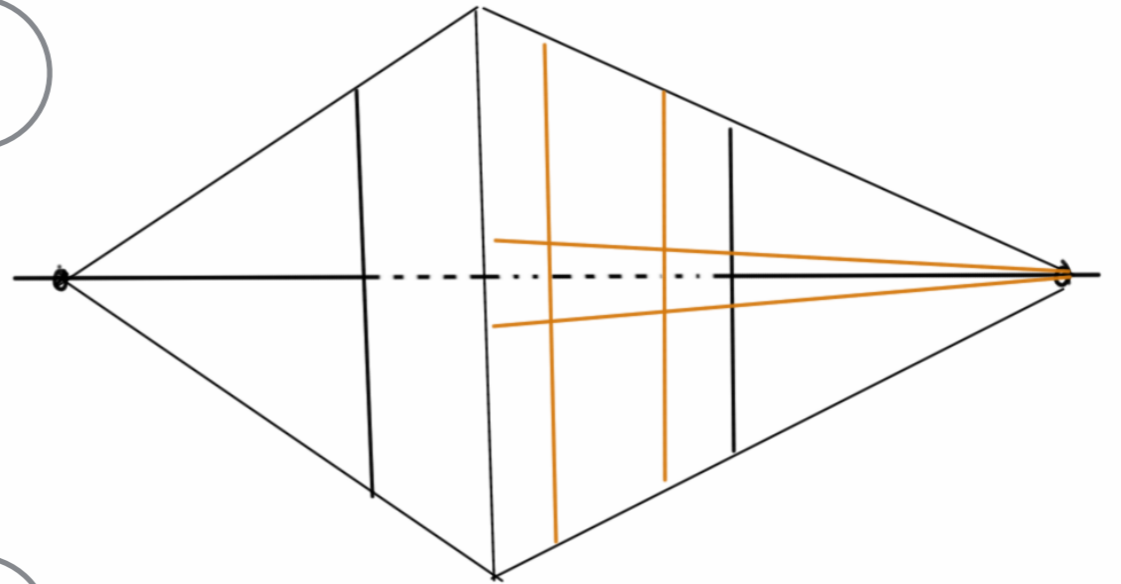

3.

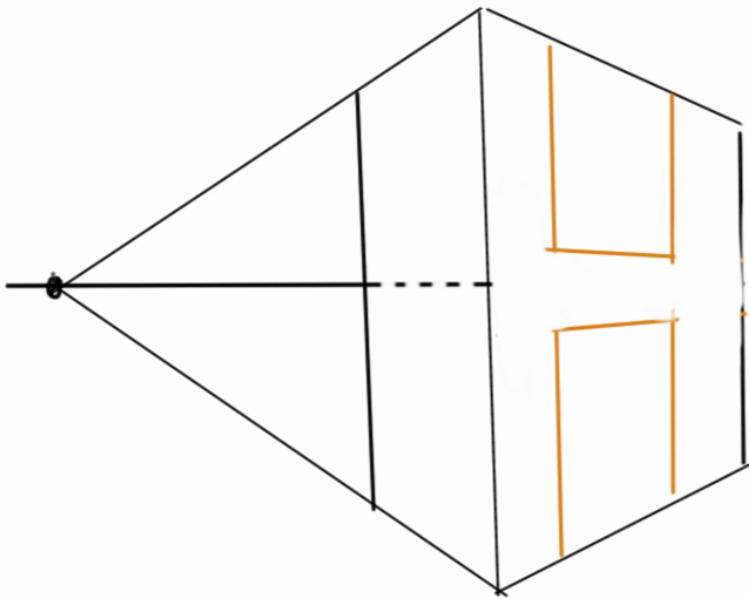

4.

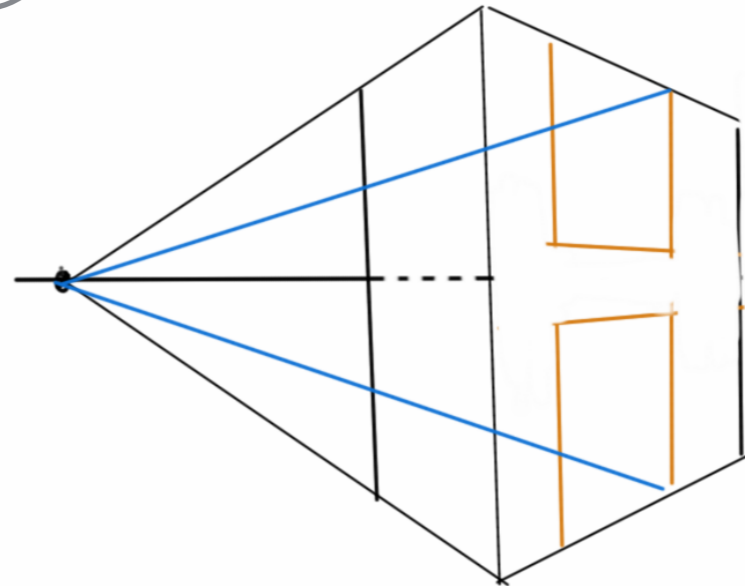

5.

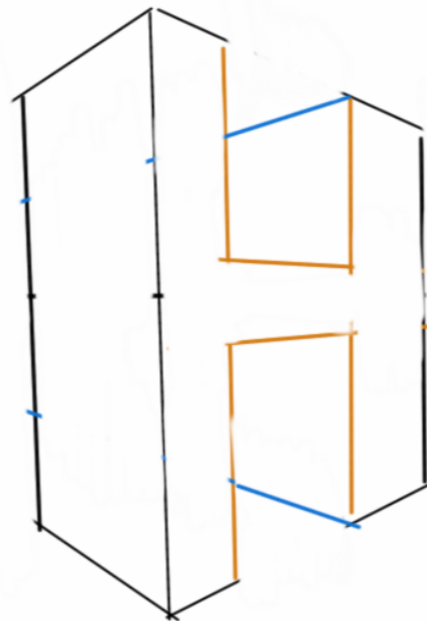

LETTERS WITH
STRAIGHT LINES
(E, F, H, I, L, T)

1.

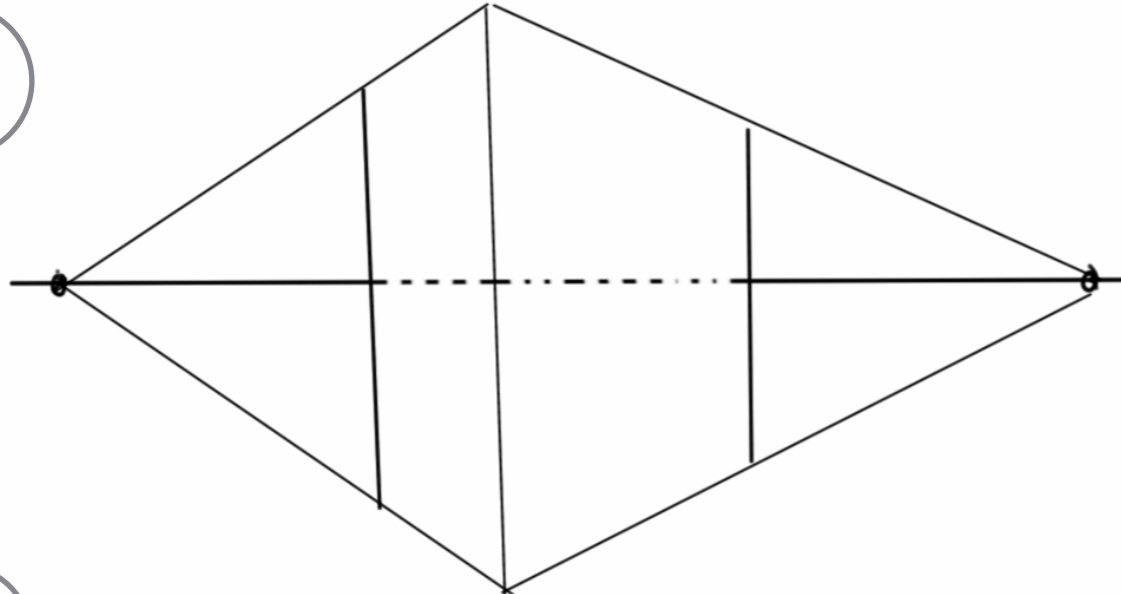

2.

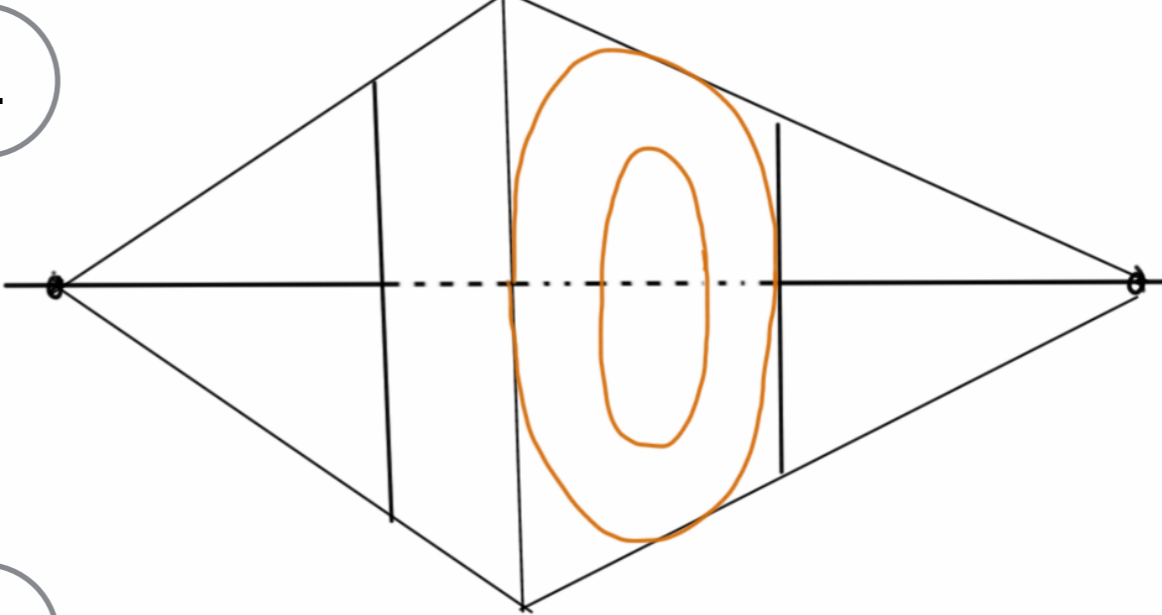

3.

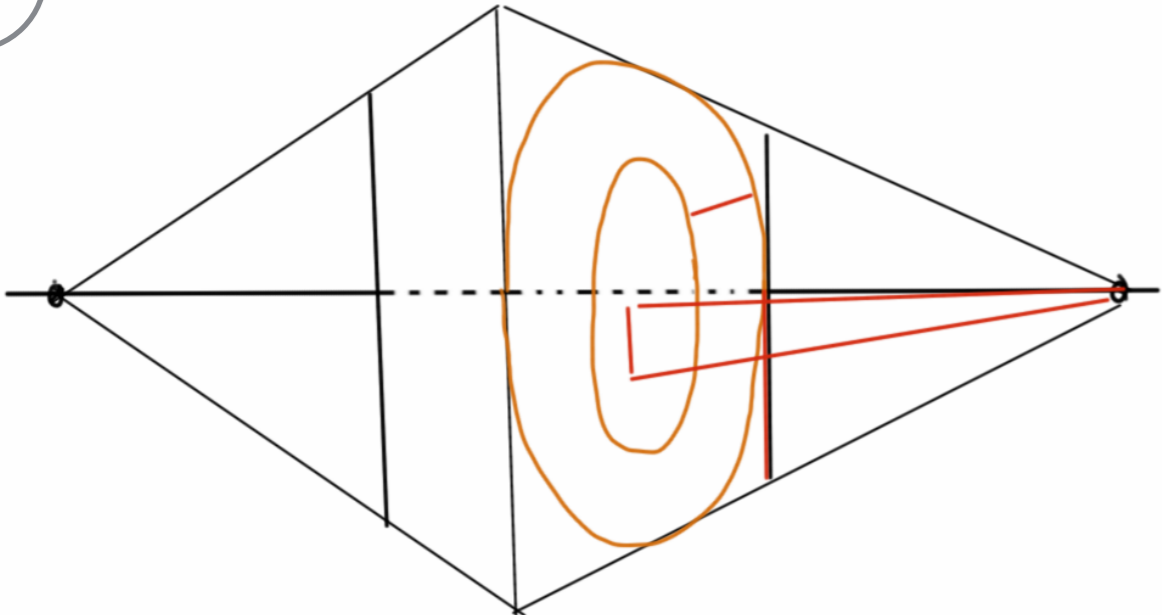

4.

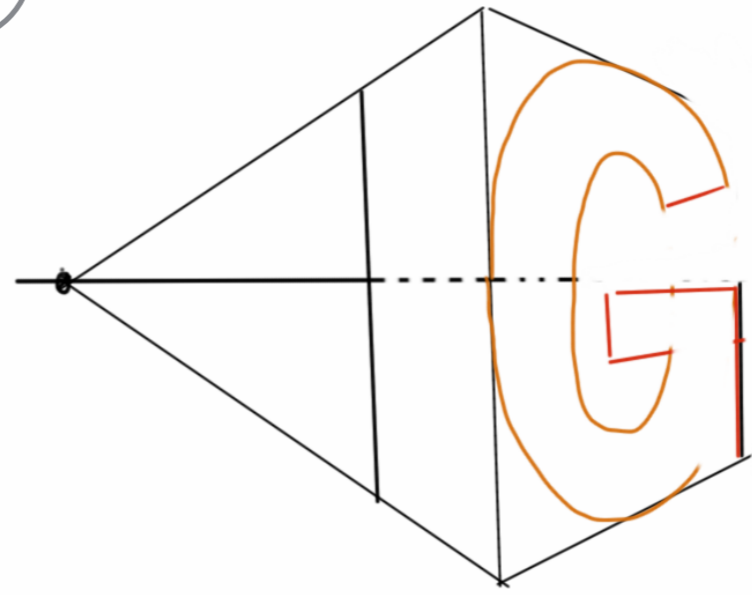

5.

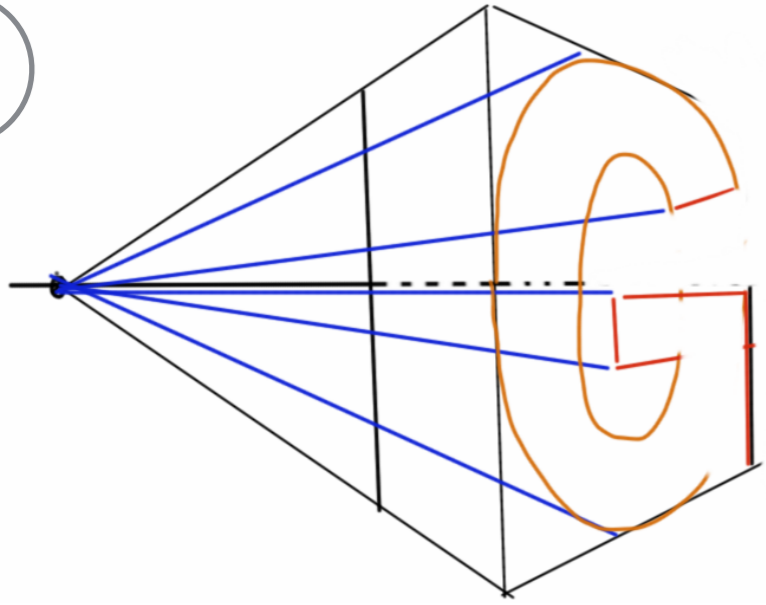

6.

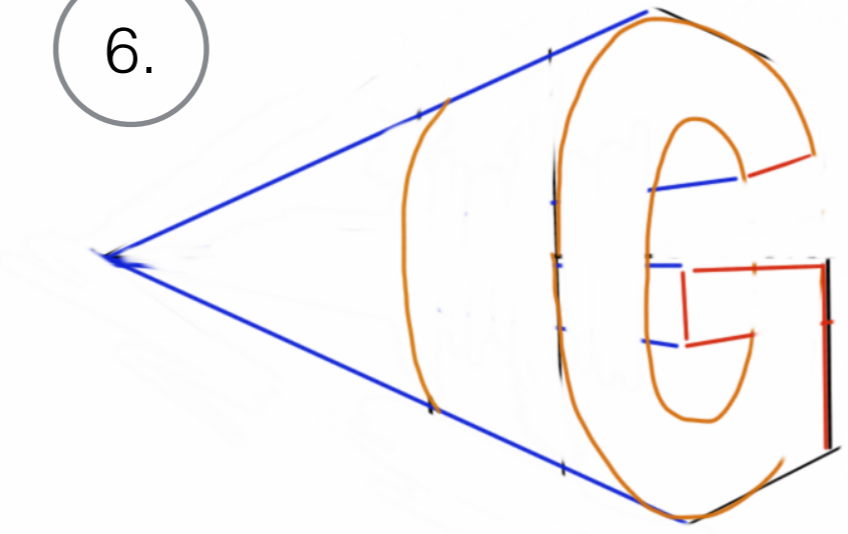

LETTERS WITH
CURVED LINES
(C, G, O, Q)

1.

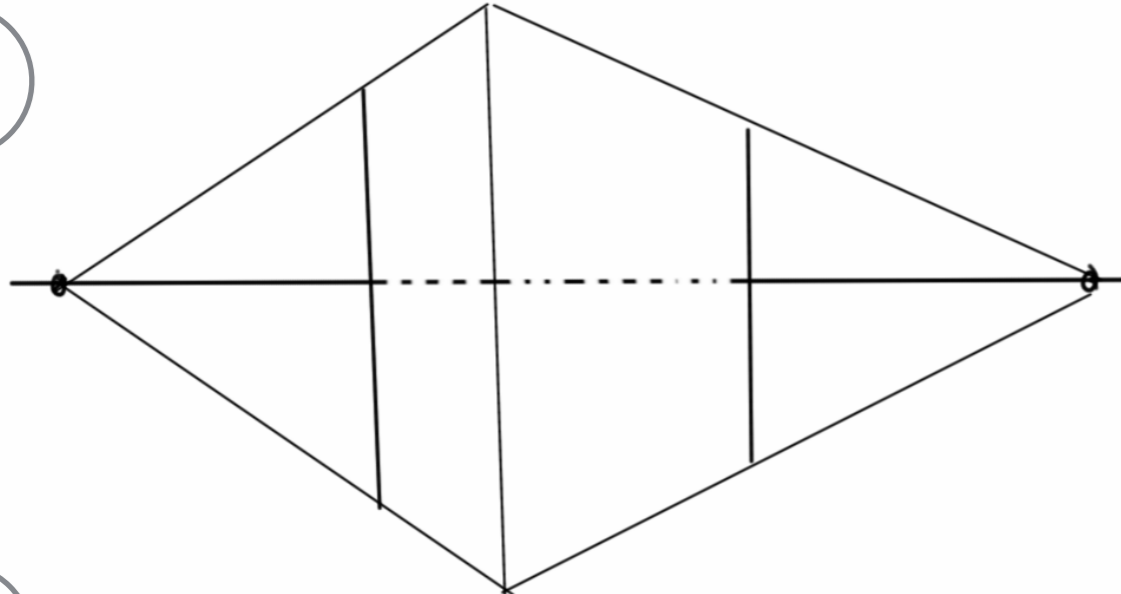

2.

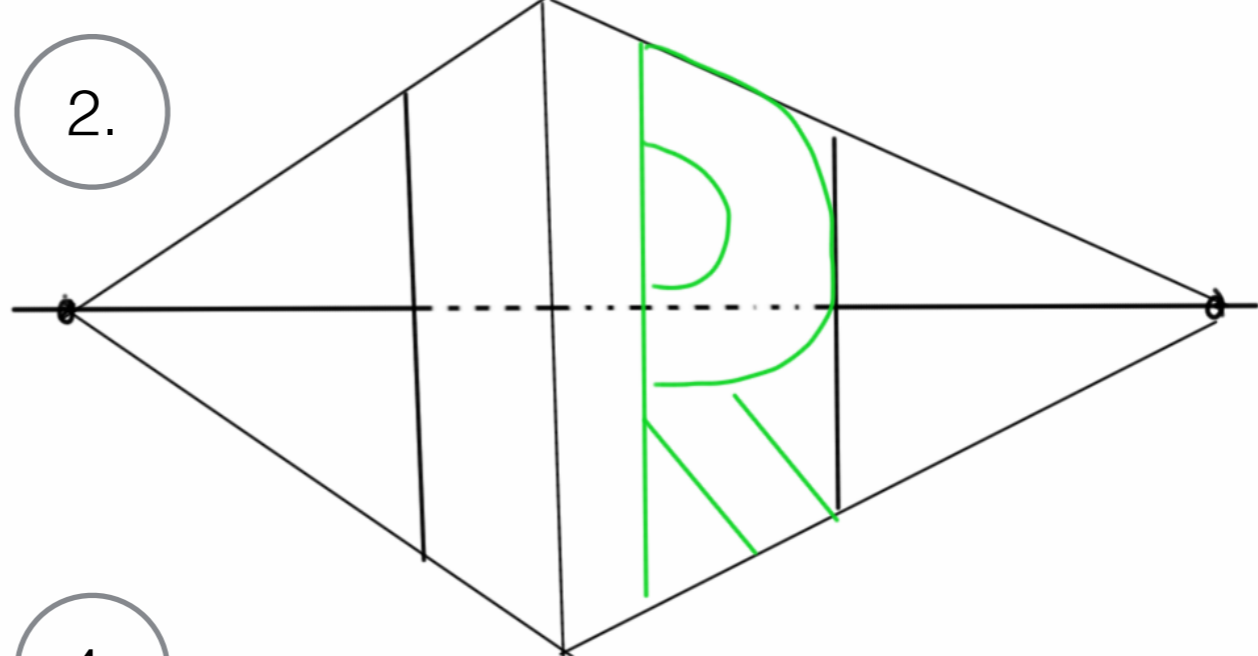

3.

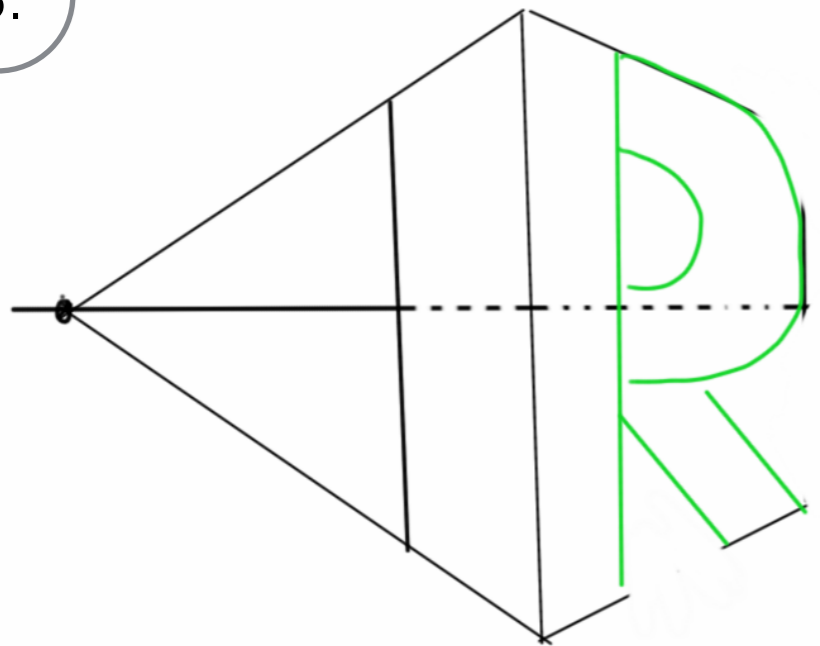

4.

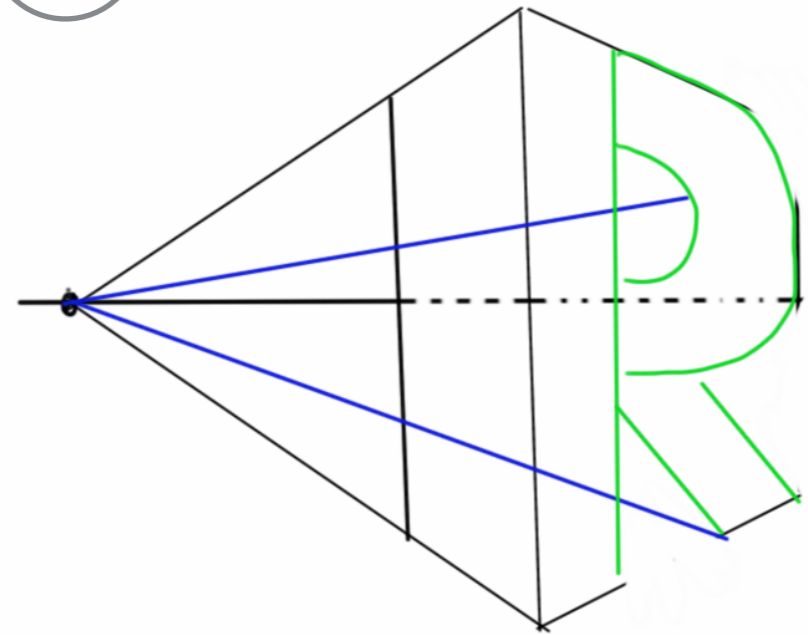

5.

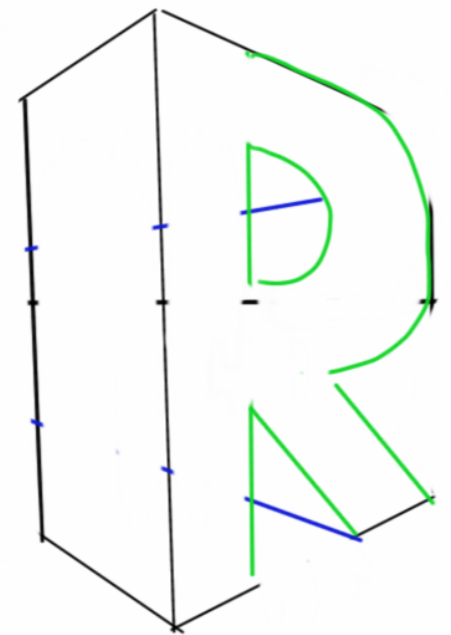

LETTERS WITH
STRAIGHT LINES and
CURVED LINES
(B, D, J, P, R, U)

1.

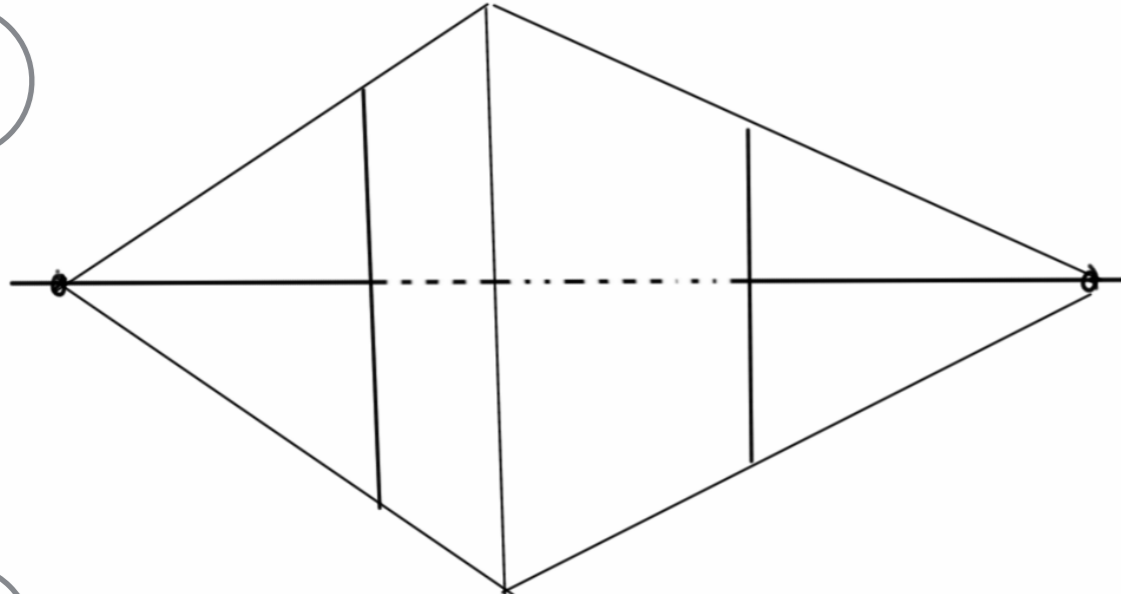

2.

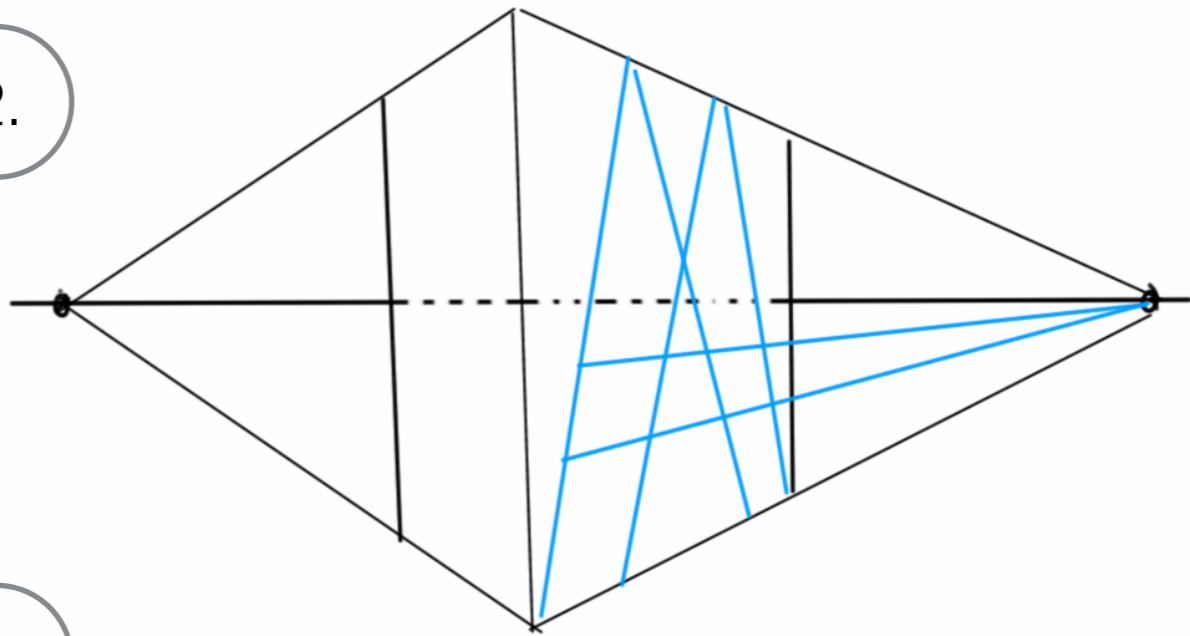

3.

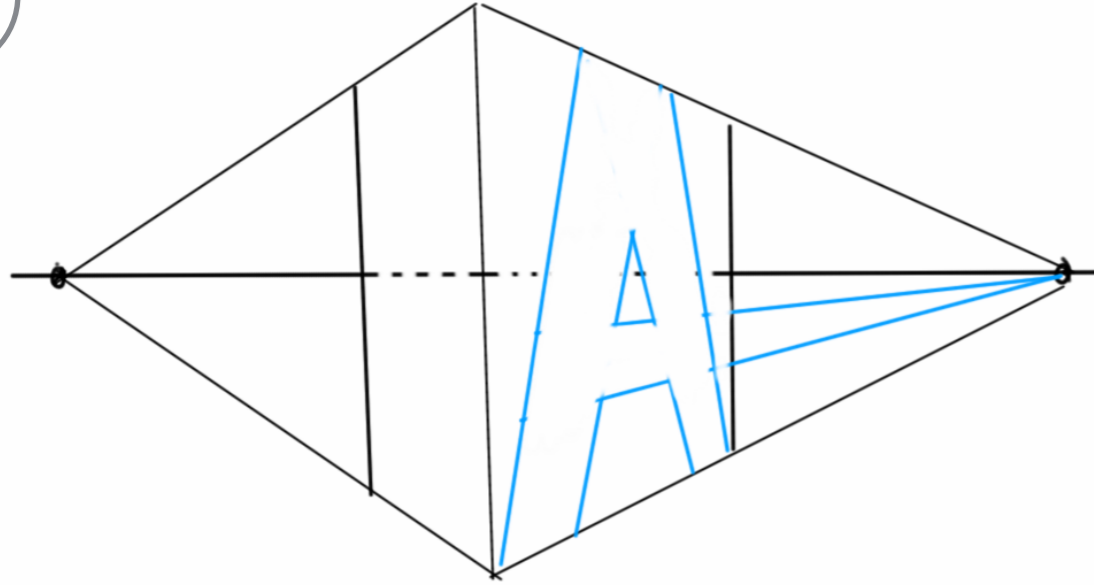

4.

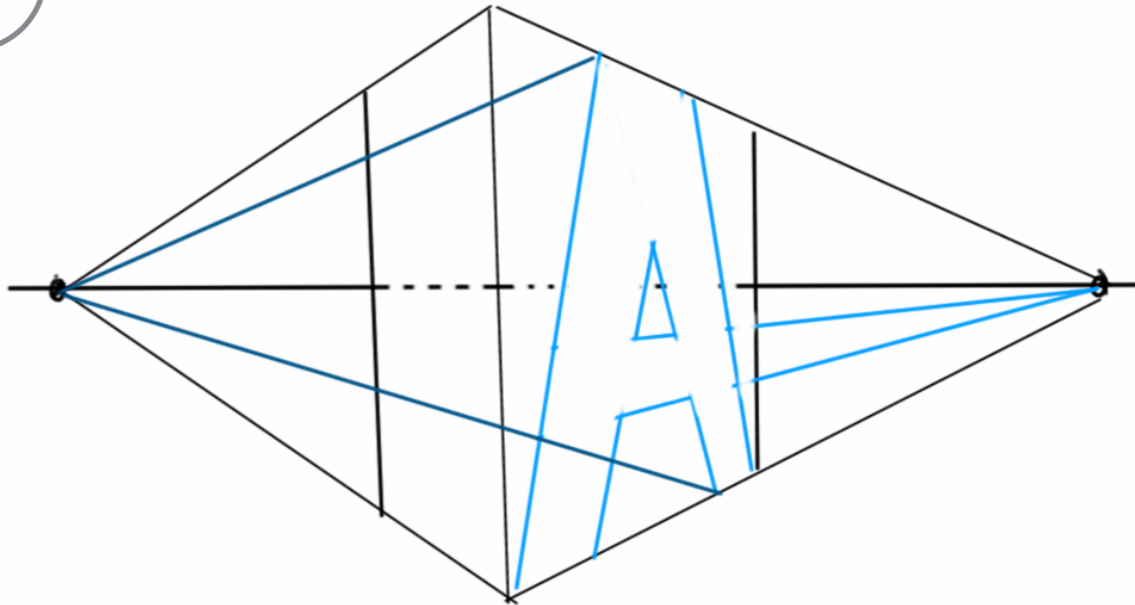

5.

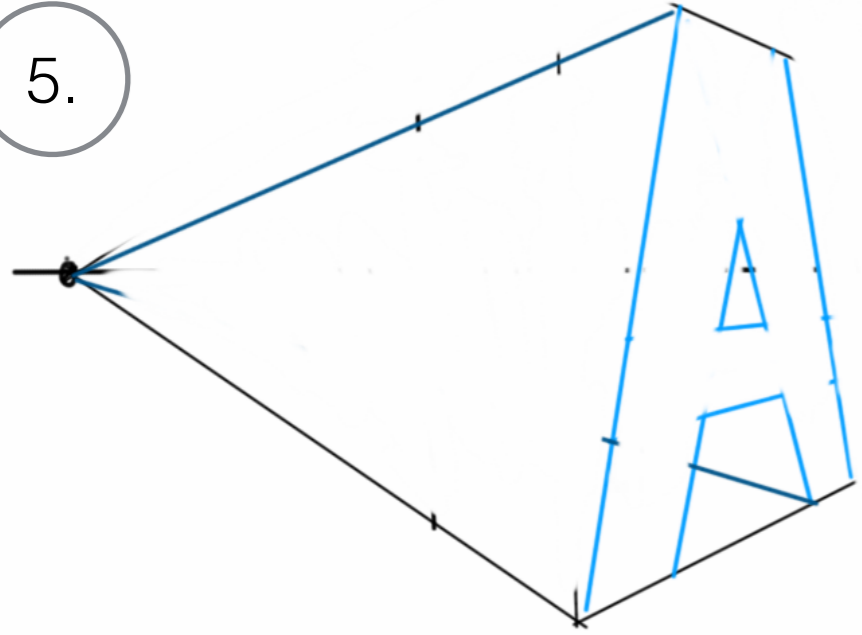

6.

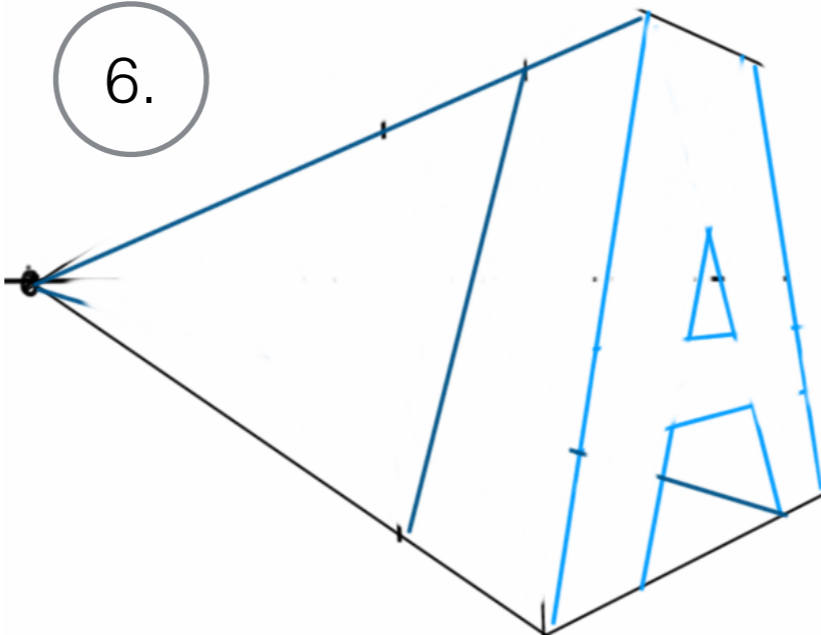

LETTERS WITH
STRAIGHT LINES and
SLANTED LINES
(A, K, M, N, V, W, X, Y, Z)